

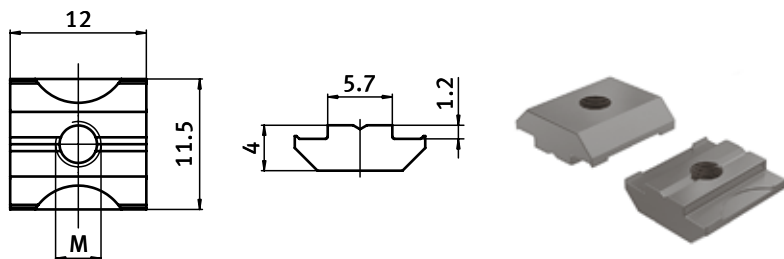

NUTENSTEIN 11,0 × 4,0 MM

T-SLOT NUT 11.0 × 4.0 MM

Ausführung	Nut 6, mit Führungssteg, Edelstahl	Model	Slot 6, self-aligning, stainless steel
Beschreibung	Nutenstein mit Führungssteg, ⚡ elektrostatisch entladend	Description	Self-aligning T-slot nut, ⚡ electrostatically discharging
Material	Edelstahl 1.4301 / 1.4305	Material	Stainless steel SS304 / SS303
Liefereinheit	100 Stück	Pack Quantity	100 pieces
Extras	verschiedene Längen mit mehreren Gewinden in unterschiedlichen Größen auf Anfrage	Specials	Different lengths with multiple threads in different sizes available on request



Nutenstein T-slot Nut	Größe Size	Gewicht [g] Weight [g]	Profil Profile	Teil-Nr. Part #
	M4	3.0	B	096484E
	M5	3.0	B	096485E

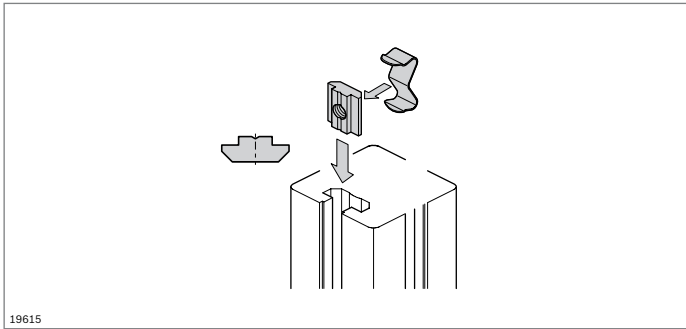

19615

Coulisseau, profilé à gorge

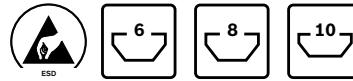

- ▶ Coulisseau pour une absorption sûre de forces importantes
- ▶ Profilé à gorge pour des éléments de fixation personnalisés à monter soi-même
- ▶ Usinage des profilés : inutile
- ▶ Ressort servant d'aide au montage et au positionnement pour le coulisseau et le coulisseau orientable (p. 3-8)



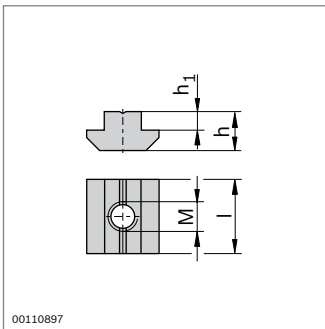









Caractéristiques techniques (p. 19-5)



00110897

Rainure	
6 (M5)	3 000 N
8 (M8)	6 000 N
10 (M8)	8 000 ... 24 000 N ¹⁾

¹⁾ En fonction du profilé (p. 19-5)

Coulisseau	Rainure	M	h (mm)	h ₁ (mm)	l (mm)	ESD		N°	
Acier ; galvanisé	6	M4	4,0	1,0	12		100	3 842 542 692	
		M5	4,0	1,0	12		100	3 842 542 693	
	8	M4	6,0	2,0	16		100	3 842 514 928	
		M5	6,0	2,0	16		100	3 842 514 929	
		M6	6,0	2,0	16		100	3 842 514 930	
	10	M8	6,0	2,0	16		100	3 842 514 931	
		M5	10,5	5,0	20		100	3 842 528 741	
		M6	10,5	5,0	20		100	3 842 528 738	
	Acier ; inoxydable	6	M4	4,0	1,0	12		100	3 842 523 140
			M5	4,0	1,0	12		100	3 842 523 142
		8	M4	6,0	2,0	16		100	3 842 547 817
			M5	6,0	2,0	16		100	3 842 547 816
M6			6,0	2,0	16		100	3 842 547 815	
10		M8	6,0	2,0	16		100	3 842 547 814	
		M5	10,5	5,0	20		100	3 842 547 813	
		M6	10,5	5,0	20		100	3 842 547 812	
			M8	10,5	5,0	20		100	3 842 547 811

Accessoires : Ressort (p. 3-9)

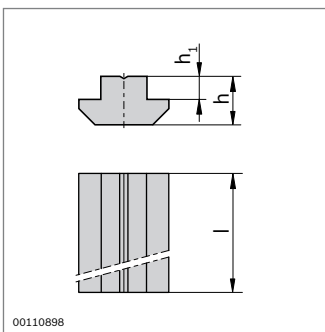

00110898

Profilé à gorge	Rainure	h (mm)	h ₁ (mm)	l (mm)	N°
Acier ; galvanisé	6	4,0	1,0	1000	3 842 542 694
	8	6,0	2,0	1000	3 842 510 078
	10	10,5	5,0	1000	3 842 528 744
Acier ; inoxydable	6	4,0	1,0	1000	3 842 523 438

Accessoires : Ressort (p. 3-9)



NUTENSTEIN 19,5 × 10,6 MM

T-SLOT NUT 19.5 × 10.6 MM

Ausführung	Nut 10, mit Führungssteg, Stahl / Edelstahl	Model	Slot 10, self-aligning, steel / stainless steel
Beschreibung	Nutenstein mit Führungssteg	Description	Self-aligning T-slot nut
Material	Stahl, verzinkt / Edelstahl 1.4301 / 1.4305	Material	Zinc plated steel / stainless steel SS304 / SS303
Liefereinheit	100 Stück	Pack Quantity	100 pieces
Extras	verschiedene Längen mit mehreren Gewinden in unterschiedlichen Größen auf Anfrage	Specials	Different lengths with multiple threads in different sizes available on request

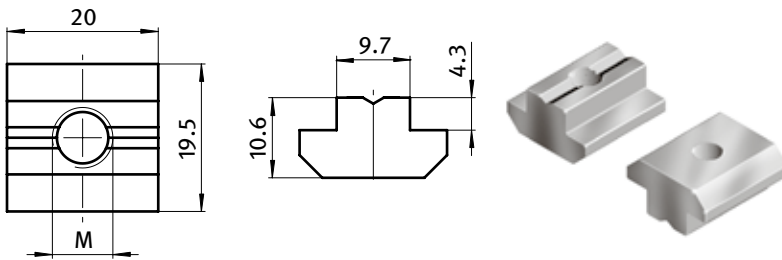

Nutenstein <i>T-slot Nut</i>	Größe <i>Size</i>	Gewicht [g] <i>Weight [g]</i>	Teil-Nr. <i>Part #</i>
Stahl <i>Steel</i>	M5	22.0	096395
	M6	20.4	096396
	M8	20.0	096398
Edelstahl <i>Stainless steel</i>	M6	22.6	096396E
	M8	21.0	096398E